

TIPOLOGIE CELLULE PER ALBERGHI RESIDENZIALI E RESIDENZE

TIPO A

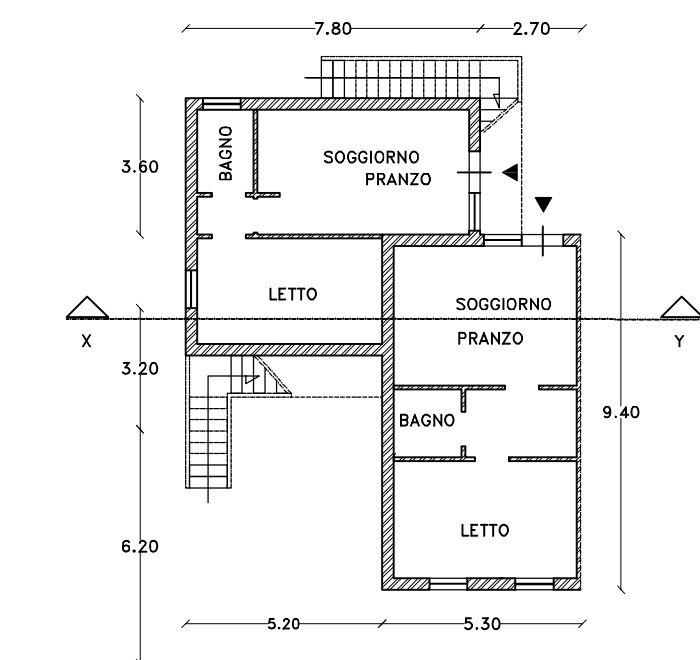

PIANTA PIANO TERRA

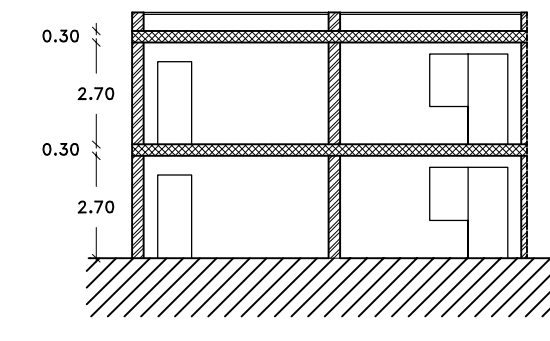

SEZIONE X-Y

TIPO A'

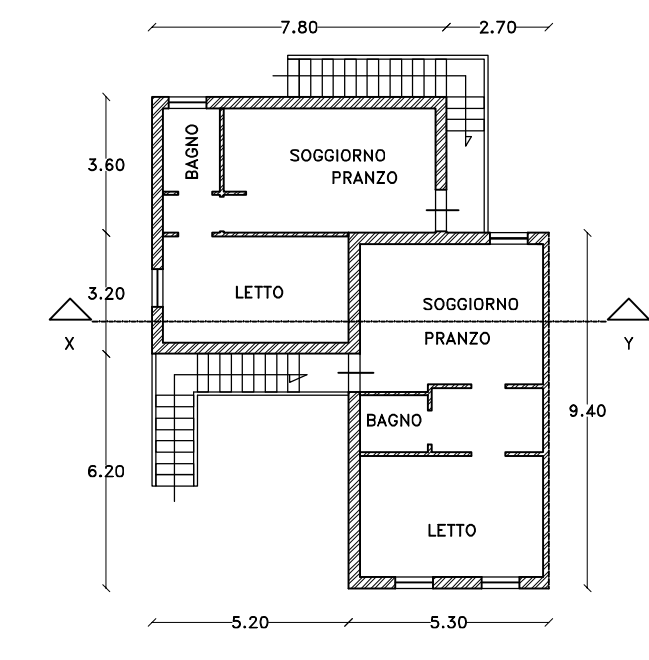

PIANTA PIANO PRIMO

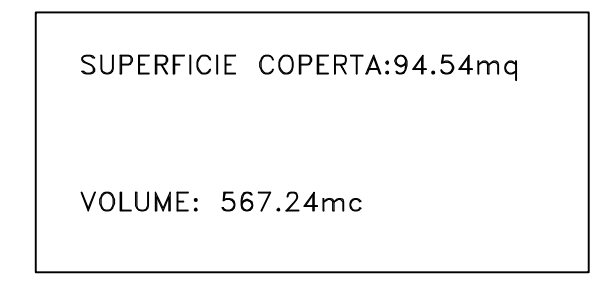

SEZIONE X-Y

SUPERFICIE COPERTA: 94,54mq
VOLUME: 567,24mc

TIPO B

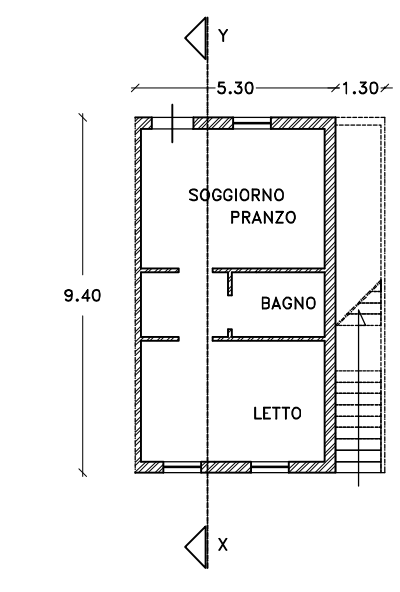

PIANTA PIANO TERRA

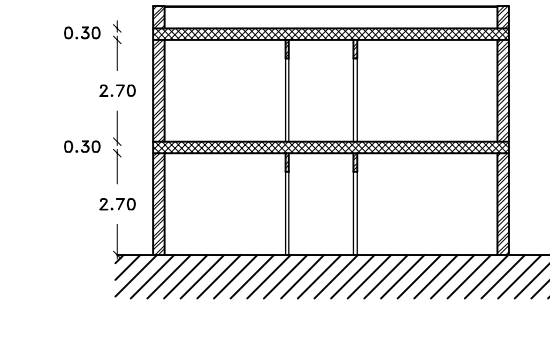

SEZIONE X-Y

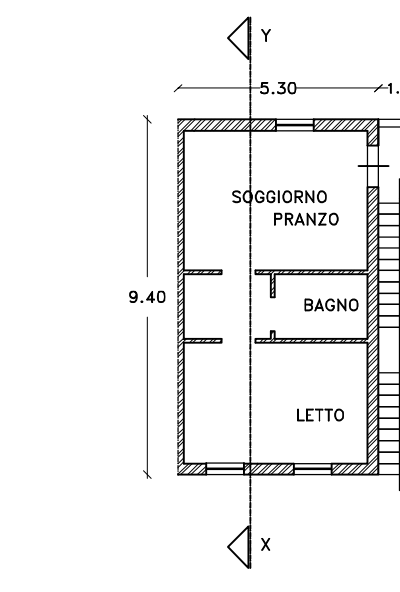

PIANTA PIANO PRIMO

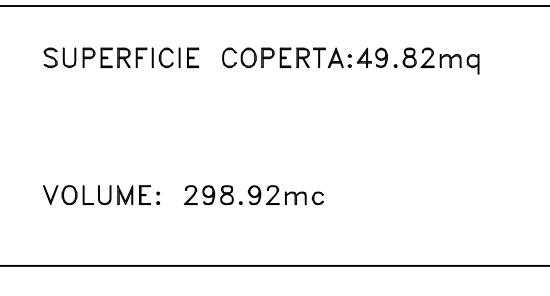

SEZIONE X-Y

SUPERFICIE COPERTA: 49,82mq
VOLUME: 298,92mc

TIPO C

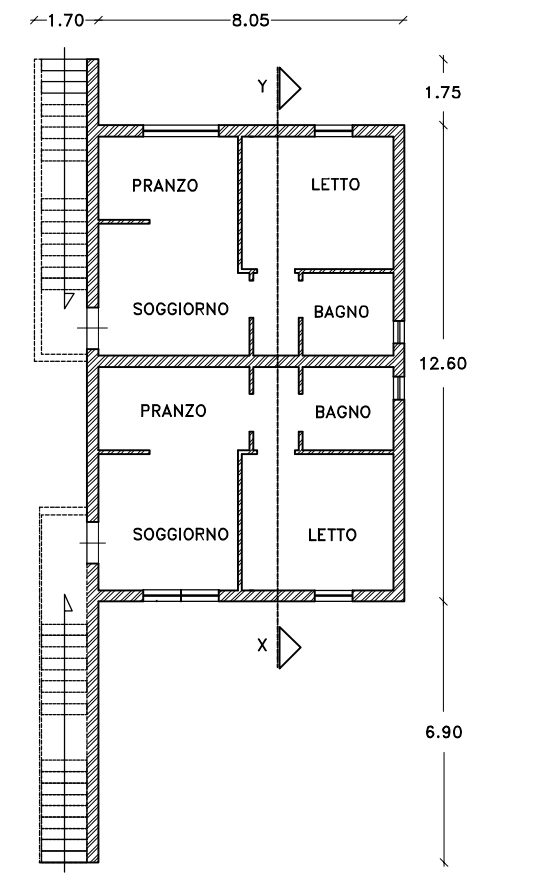

PIANTA PIANO TERRA

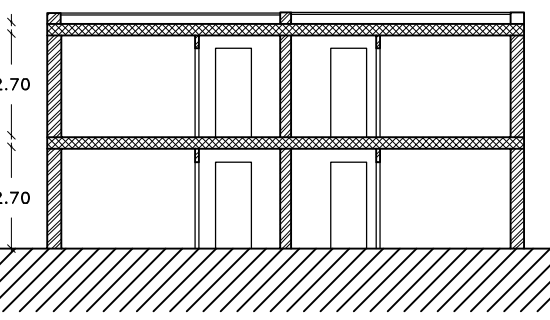

SEZIONE X-Y

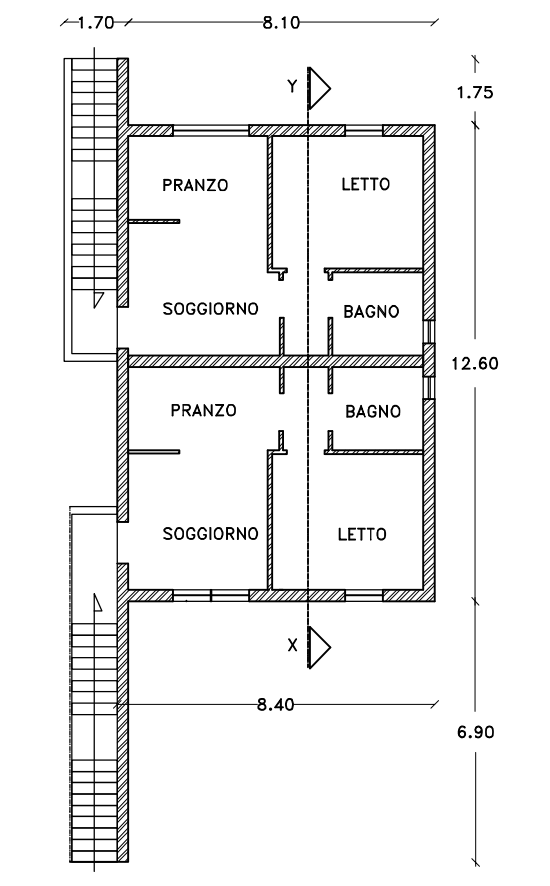

PIANTA PIANO PRIMO

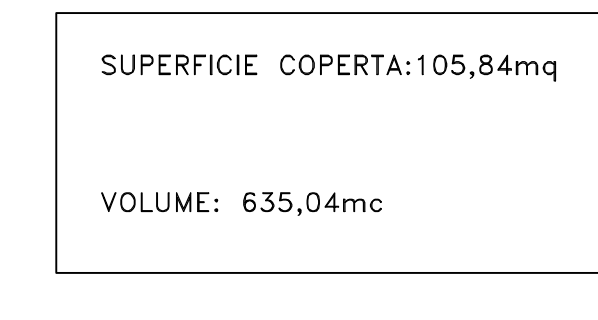

SEZIONE X-Y

SUPERFICIE COPERTA: 105,84mq
VOLUME: 635,04mc

TIPO D

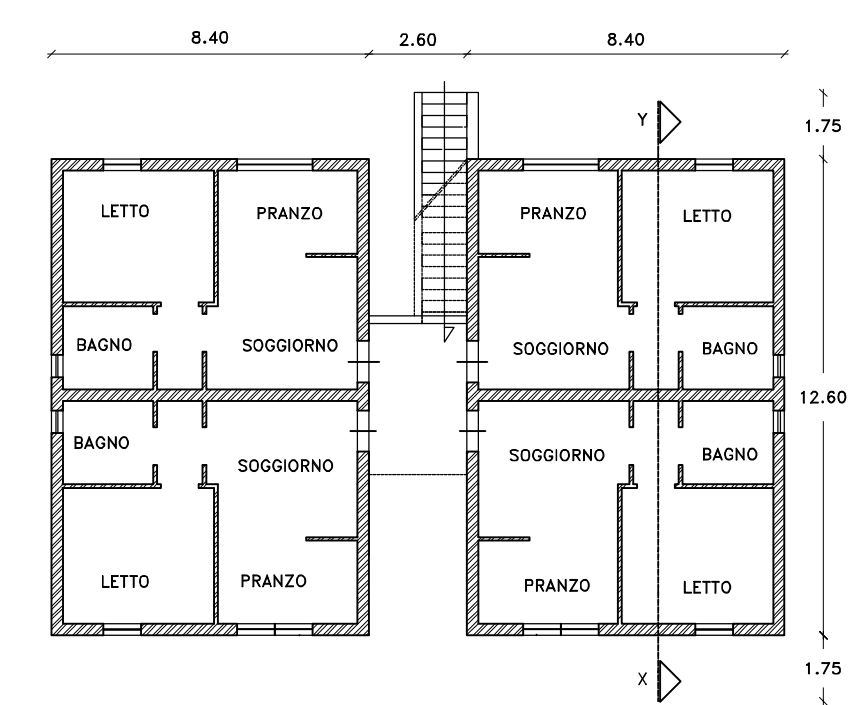

PIANTA PIANO TERRA

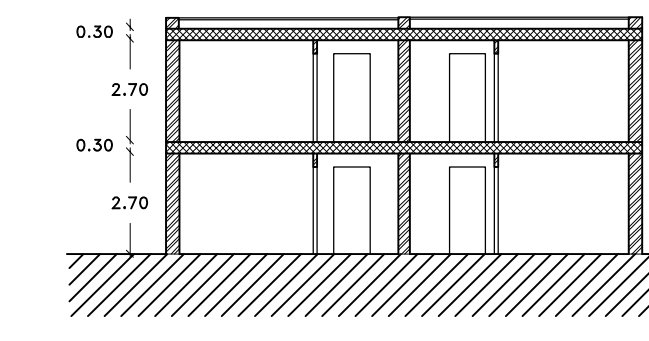

SEZIONE X-Y

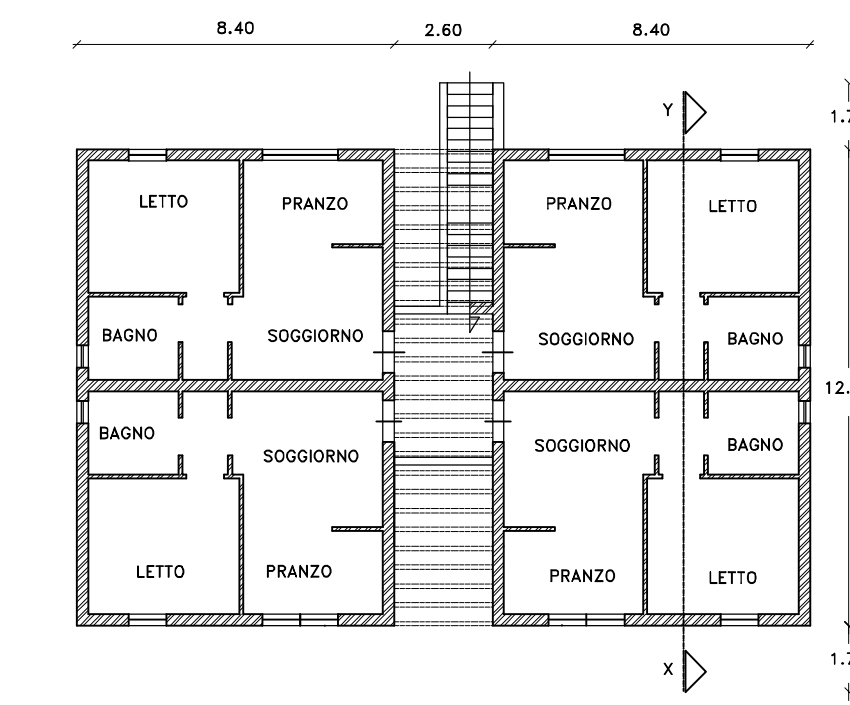

PIANTA PIANO PRIMO

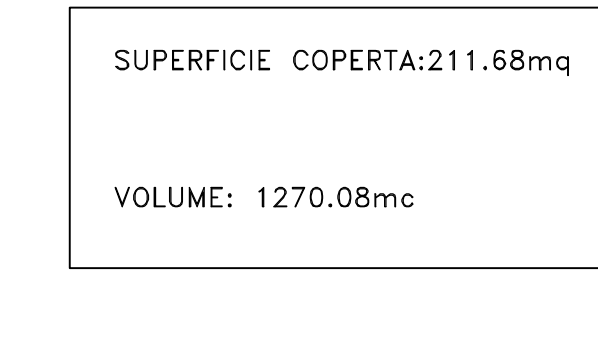

SEZIONE X-Y

SUPERFICIE COPERTA: 211,68mq
VOLUME: 1270,08mc

TIPO D'

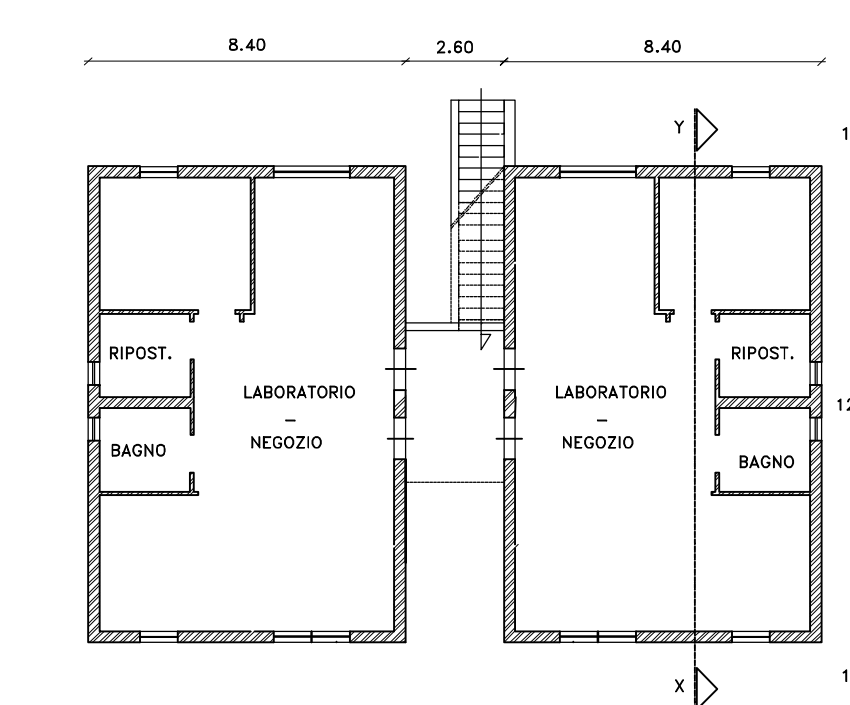

PIANTA PIANO TERRA

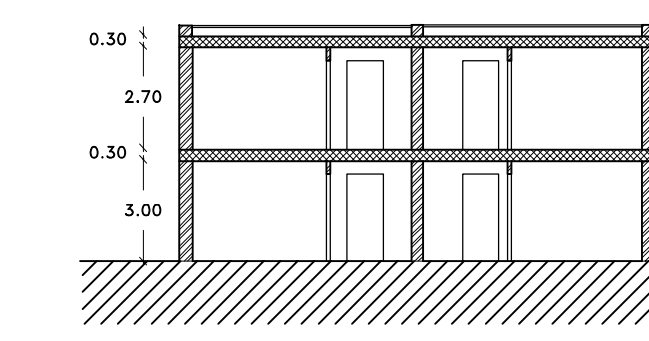

SEZIONE X-Y

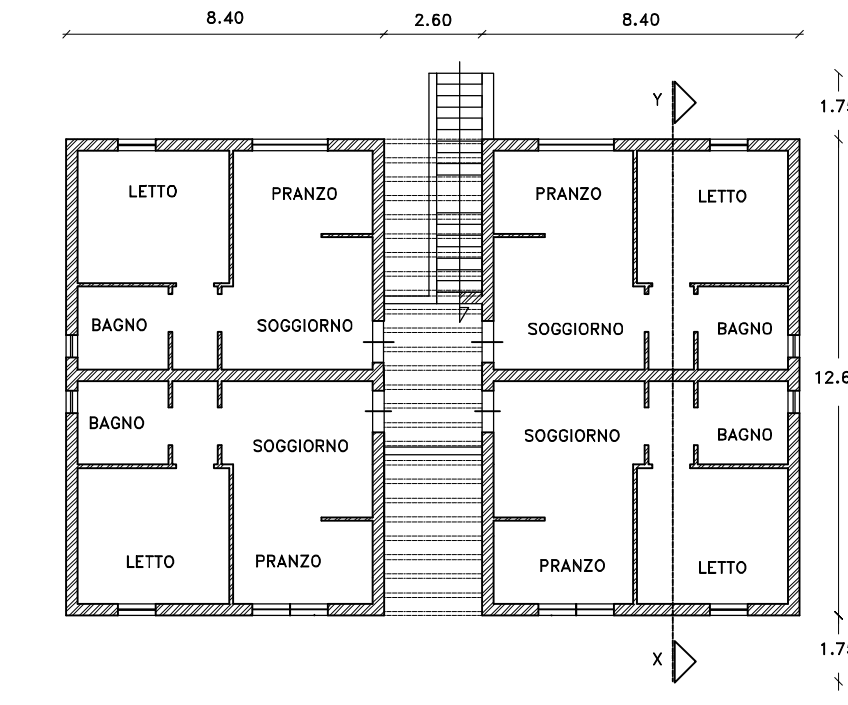

PIANTA PIANO PRIMO

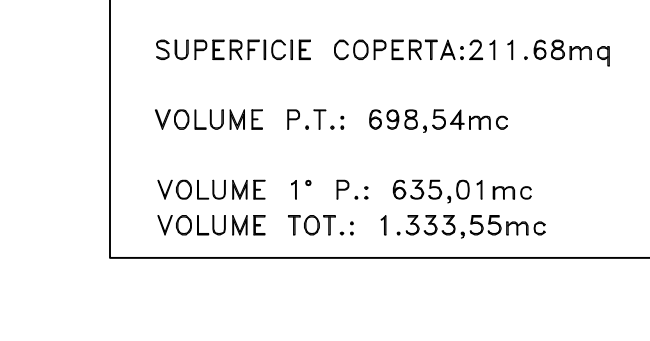

SEZIONE X-Y

SUPERFICIE COPERTA: 211,68mq
VOLUME P.T.: 698,54mc
VOLUME 1° P.: 635,01mc
VOLUME TOT.: 1.333,55mc

TIPO B'

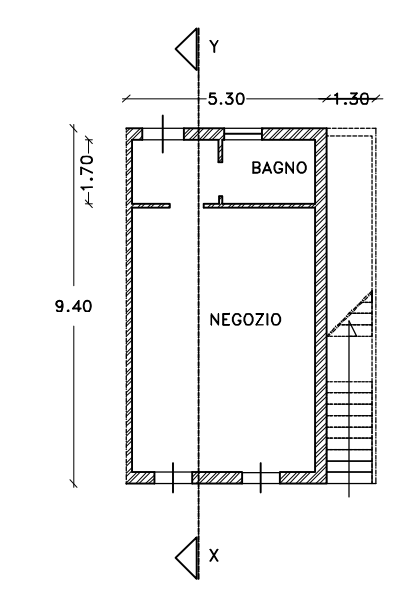

PIANTA PIANO TERRA

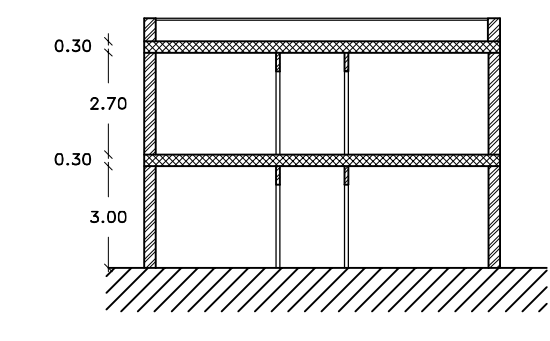

SEZIONE X-Y

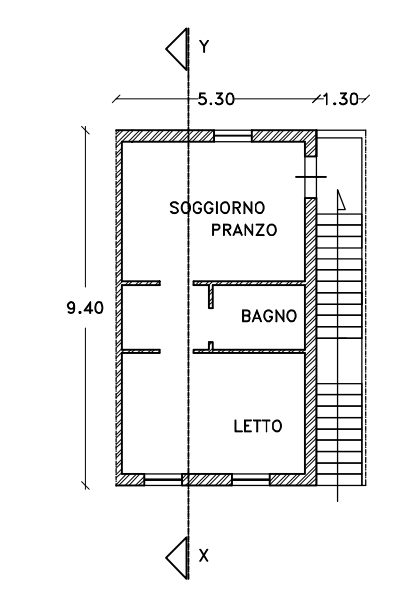

PIANTA PIANO PRIMO

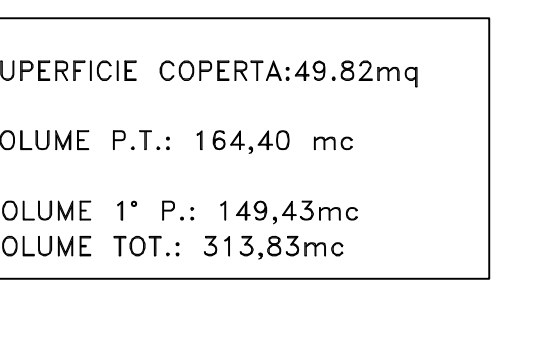

SEZIONE X-Y

SUPERFICIE COPERTA: 49,82mq
VOLUME P.T.: 164,40 mc
VOLUME 1° P.: 149,43mc
VOLUME TOT.: 313,83mc